

MiMi 41923

Over 300 leathers and fabrics to choose from. Your choice...

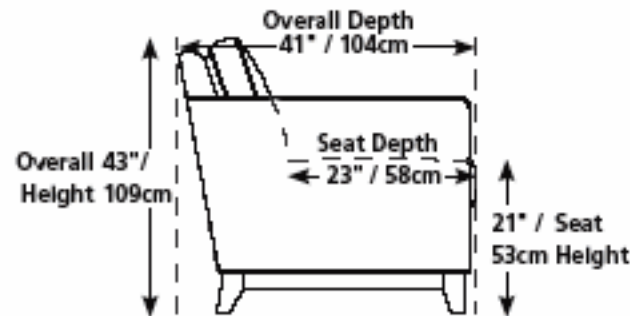

Wallhugger – fully reclines with only 2" / 5cm wall clearance, allowing greater decorating flexibility and more efficient use of space.

Depth in full recline = 65" / 165cm
Configuration depths will vary

Design • It • Yourself



Imagine the impact of a full cinematic experience right in your own home!
Palliser® Home Theater Seating combines unparalleled comfort, sophisticated design and all the features you need to help create the ultimate home theater.

This modular system is available in straight or curved configurations. You can customize the configuration to fit your family size and living space with as many seats across as you need. This product ships with fully attached arms and wedges.

AVAILABLE WITH ALL SKUs (1, 2, 3, 5, 6, 7)

For SKU options, replace "R" with:
E = power recline
W = manual with wireless bass shaker
L = power with wireless bass shaker

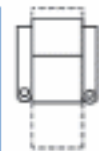

42" x 65"
107cm x 165cm
1R – manual recliner



35" x 65"
89cm x 165cm
2R – manual LHF recliner



35" x 65"
89cm x 165cm
3R – manual RHF recliner



49" x 65"
124cm x 165cm
5R – manual LHF recliner with RHF wedge arm



49" x 65"
124cm x 165cm
6R – manual RHF recliner with LHF wedge arm



42" x 65"
107cm x 165cm
7R – manual RHF wedge arm recliner

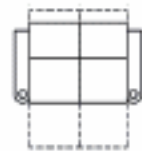

70" x 65"
178cm x 165cm
2R/3R

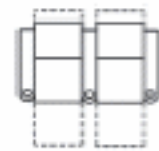

77" x 65"
196cm x 165cm
1R/3R

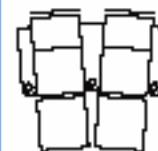

84" x 68"
213cm x 173cm
5R/3R

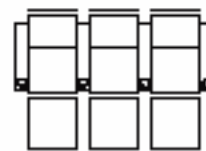

112" x 65"
284cm x 165cm
1R/3R/3R

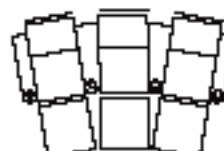

124" x 71"
315cm x 180cm
5R/7R/3R

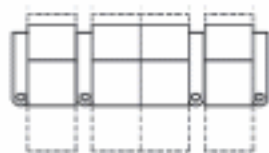

140" x 65"
356cm x 165cm
2R/2R/3R/3R

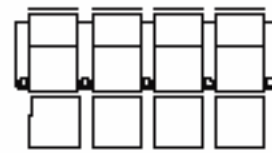

147" x 65"
373cm x 165cm
1R/3R/3R/3R



189" x 79"
465cm x 201cm
5R/7R/7R/3R

Features...



Easy to clean removable cup holder on every arm (color options available)



Wall hugger design that needs only 6 inches of wall clearance

Also available...

Wireless Bass Shaker System that creates the sensation of being part of the movie, providing the ultimate in Home Theater experience.



RF (radio frequency 2.4 GHZ) transmitter plugs into home theater amplifier that will supply signal to all bass shaker units within 200 ft radius



50 watt (4 ohms) amplifier built into seat of chair



RF receiver built into seat of chair

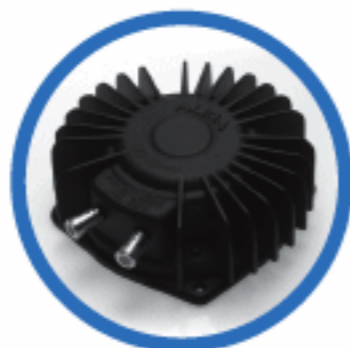

Bass shaker mounted within the seat back has a nominal impedance of 4 ohms

All you need to get started...

- Plug transmitter into home theater amplifier
- Plug amplifier into the power source of your seating unit
- Adjust individual intensity to your comfort level
- No wires to connect between seats and home theater system
- Wired bass shaker available upon request

1

Choose your style

2

Choose your configuration

3

Choose your electronics

4

Choose your cover over 300 leathers & fabrics

5

Enjoy your movie

OR

Visit palliser.com and click on the Room Builder box to create your own configuration to fit your home perfectly.